

Working Voltage: 5.0 to 190 V
Peak Pulse Power: 500 W

Axial Lead Transient Voltage Suppressors

Features

- Glass passivated chip
- 500 W peak pulse power capability with a 10/1000 μ s waveform, repetitive rate (duty cycle):0.01 %
- Low leakage
- Uni and Bidirectional unit
- Excellent clamping capability
- Very fast response time
- RoHS compliant

Mechanical Data

- Case: Molded plastic
- Epoxy: UL 94V-0 rate flame retardant
- Lead: Solderable per MIL-STD-202, method 208 guranteed
- Polarity: Color band denotes cathode end except Bipolar
- Mounting position: Any

DO-15

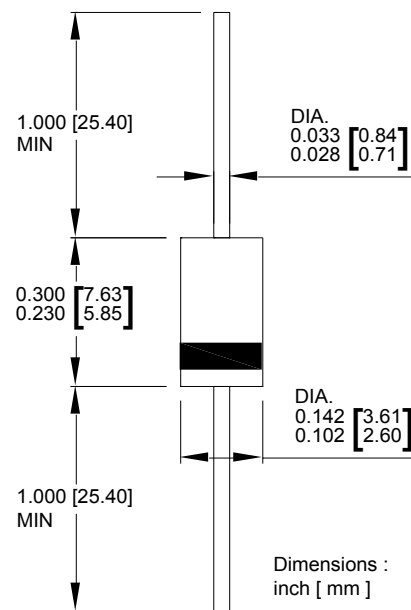

Maximum Ratings($T_A=25^\circ\text{C}$ unless otherwise noted)

Parameter	Symbol	Value	Unit
Peak power dissipation with a 10/1000 μ s waveform ⁽¹⁾	P_{PP}	500	W
Peak pulse current with a 10/1000 μ s waveform ⁽¹⁾	I_{PP}	See Next Table	A
Power dissipation on infinite heatsink at $T_L = 75^\circ\text{C}$	P_D	3.0	W
Peak forward surge current, 8.3 ms single half sine-wave unidirectional only ⁽²⁾	I_{FSM}	70	A
Maximum instantaneous forward voltage at 25 A for unidirectional only ⁽³⁾	V_F	3.5/5.0	V
Operating junction and storage temperature range	T_J, T_{STG}	-55 to +150	$^\circ\text{C}$

Note:

(1)Non-repetitive current pulse per Fig.5 and derated above $T_A = 25^\circ\text{C}$ per Fig.1

(2)Measured on 8.3 ms single half sine-wave or equivalent square wave, duty cycle = 4 pulses per minute maximum

(3) $V_F < 3.5\text{V}$ for devices of $V_{BR} \leq 200\text{V}$ and $V_F < 5.0\text{V}$ for devices of $V_{BR} \geq 201\text{V}$

Ratings and Characteristics Curves ($T_A=25^{\circ}\text{C}$ unless otherwise noted)

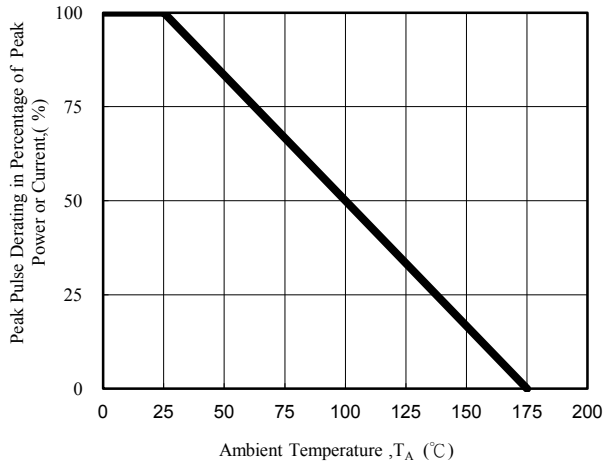

Fig. 1 - Pulse Derating Curve

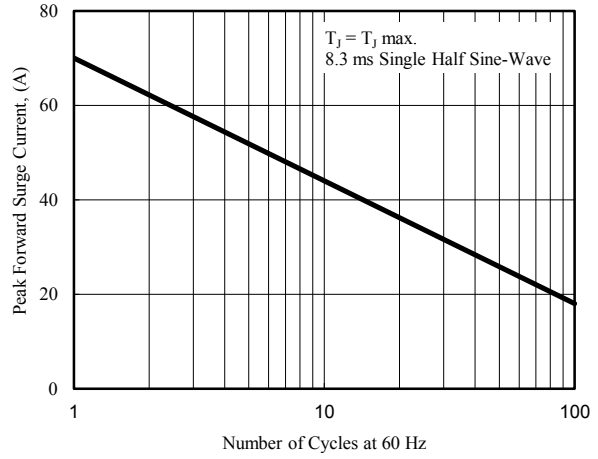

Fig. 2 - Maximum Non-Repetitive Surge Current

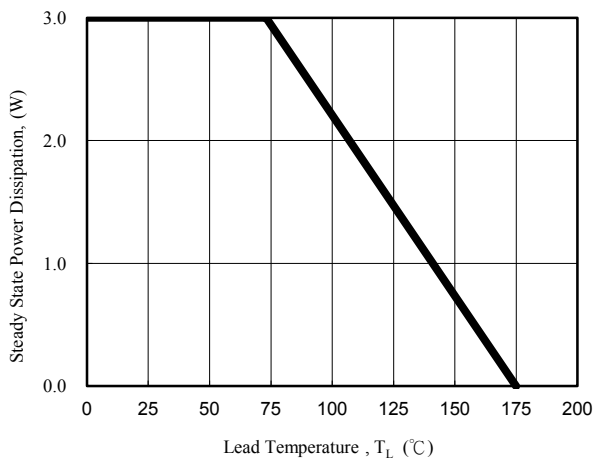

Fig. 3 - Steady State Power Derating Curve

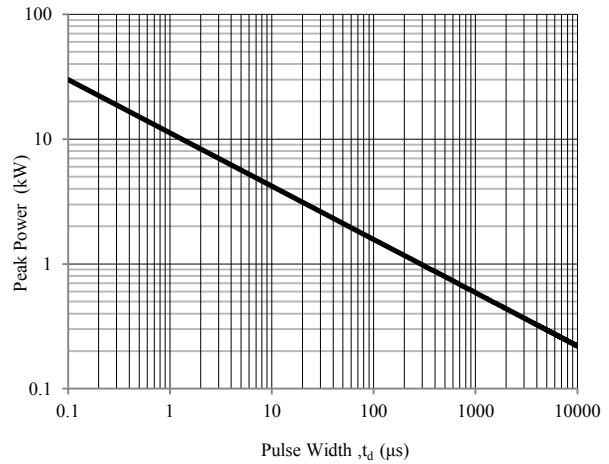

Fig. 4 - Peak Pulse Power Rating Curve

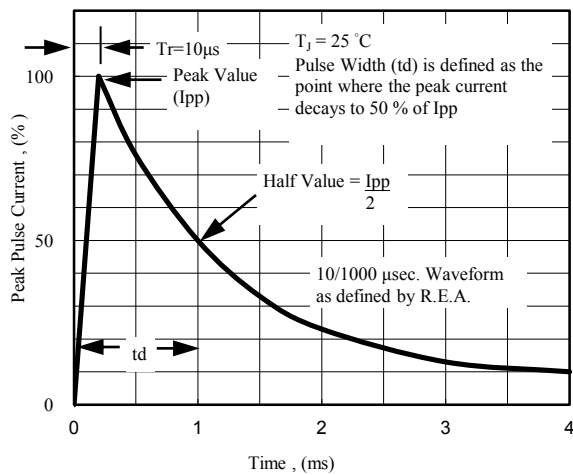

Fig. 5 - Pulse Waveform

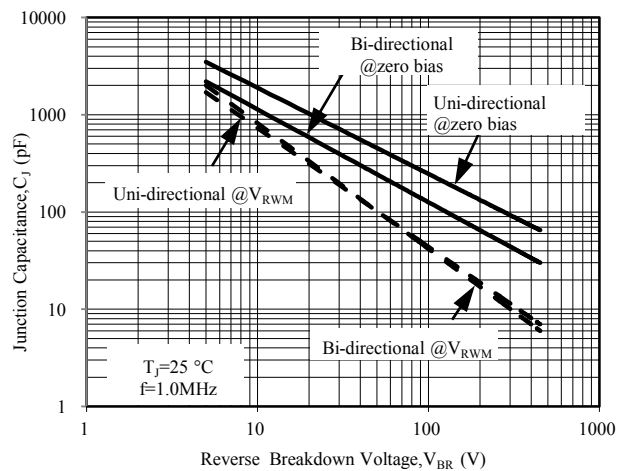

Fig. 6 - Typical Junction Capacitance

Electrical Characteristics($T_A=25^{\circ}C$ unless otherwise noted)

Part Number (Uni)	Part Number (Bi)	Breakdown Voltage V_{BR} @ I_T			Maximum Reverse Leakage I_R @ V_{RWM} (μA)	Working Peak Reverse Voltage V_{RWM} (V)	Maximum Reverse Surge Current I_{PP} (A)	Maximum Clamping Voltage V_C @ I_{PP} (V)
		Min (V)	Max (V)	I_T (mA)				
SA5.0	SA5.0C	6.40	7.30	10	600	5.0	52.08	9.6
SA5.0A	SA5.0CA	6.40	7.00	10	600	5.0	54.35	9.2
SA6.0	SA6.0C	6.67	8.15	10	600	6.0	43.86	11.4
SA6.0A	SA6.0CA	6.67	7.37	10	600	6.0	48.54	10.3
SA6.5	SA6.5C	7.22	8.82	10	400	6.5	40.65	12.3
SA6.5A	SA6.5CA	7.22	7.98	10	400	6.5	44.64	11.2
SA7.0	SA7.0C	7.78	9.51	10	150	7.0	37.59	13.3
SA7.0A	SA7.0CA	7.78	8.60	10	150	7.0	41.67	12.0
SA7.5	SA7.5C	8.33	10.20	1	50	7.5	34.97	14.3
SA7.5A	SA7.5CA	8.33	9.21	1	50	7.5	38.76	12.9
SA8.0	SA8.0C	8.89	10.90	1	25	8.0	33.33	15.0
SA8.0A	SA8.0CA	8.89	9.83	1	25	8.0	36.76	13.6
SA8.5	SA8.5C	9.44	11.50	1	5	8.5	31.45	15.9
SA8.5A	SA8.5CA	9.44	10.40	1	5	8.5	34.72	14.4
SA9.0	SA9.0C	10.00	12.20	1	5	9.0	29.59	16.9
SA9.0A	SA9.0CA	10.00	11.10	1	5	9.0	32.47	15.4
SA10	SA10C	11.10	13.60	1	5	10.0	26.60	18.8
SA10A	SA10CA	11.10	12.30	1	5	10.0	29.41	17.0
SA11	SA11C	12.20	14.90	1	5	11.0	24.88	20.1
SA11A	SA11CA	12.20	13.50	1	5	11.0	27.47	18.2
SA12	SA12C	13.30	16.30	1	5	12.0	22.73	22.0
SA12A	SA12CA	13.30	14.70	1	5	12.0	25.13	19.9
SA13	SA13C	14.40	17.60	1	5	13.0	21.01	23.8
SA13A	SA13CA	14.40	15.90	1	5	13.0	23.26	21.5
SA14	SA14C	15.60	19.10	1	5	14.0	19.38	25.8
SA14A	SA14CA	15.60	17.20	1	5	14.0	21.55	23.2
SA15	SA15C	16.70	20.40	1	5	15.0	18.59	26.9
SA15A	SA15CA	16.70	18.50	1	5	15.0	20.49	24.4
SA16	SA16C	17.80	21.80	1	5	16.0	17.36	28.8
SA16A	SA16CA	17.80	19.70	1	5	16.0	19.23	26.0
SA17	SA17C	18.90	23.10	1	5	17.0	16.39	30.5
SA17A	SA17CA	18.90	20.90	1	5	17.0	18.12	27.6
SA18	SA18C	20.00	24.40	1	5	18.0	15.53	32.2
SA18A	SA18CA	20.00	22.10	1	5	18.0	17.12	29.2
SA19	SA19C	21.13	25.76	1	5	19.0	14.70	34.0
SA19A	SA19CA	21.10	23.30	1	5	19.0	16.24	30.8
SA20	SA20C	22.20	27.10	1	5	20.0	13.97	35.8
SA20A	SA20CA	22.20	24.50	1	5	20.0	15.43	32.4
SA22	SA22C	24.40	29.80	1	5	22.0	12.69	39.4
SA22A	SA22CA	24.40	26.90	1	5	22.0	14.08	35.5
SA24	SA24C	26.70	32.60	1	5	24.0	11.63	43.0
SA24A	SA24CA	26.70	29.50	1	5	24.0	12.85	38.9
SA26	SA26C	28.90	35.30	1	5	26.0	10.73	46.6
SA26A	SA26CA	28.90	31.90	1	5	26.0	11.88	42.1
SA28	SA28C	31.10	38.00	1	5	28.0	10.00	50.0
SA28A	SA28CA	31.10	34.40	1	5	28.0	11.01	45.4
SA30	SA30C	33.30	40.70	1	5	30.0	9.35	53.5
SA30A	SA30CA	33.30	36.80	1	5	30.0	10.33	48.4
SA33	SA33C	36.70	44.90	1	5	33.0	8.47	59.0
SA33A	SA33CA	36.70	40.60	1	5	33.0	9.38	53.3
SA36	SA36C	40.00	48.90	1	5	36.0	7.78	64.3
SA36A	SA36CA	40.00	44.20	1	5	36.0	8.61	58.1

Note:

1. Suffix 'A' denotes 5% tolerance device. Without 'A' denotes 10% tolerance device
2. Add suffix 'C' or 'CA' after part number to specify Bi-directional devices
3. For Bi-Directional devices having V_R of 10 volts and under, the I_R limit is double

Electrical Characteristics($T_A=25^{\circ}\text{C}$ unless otherwise noted)

Part Number (Uni)	Part Number (Bi)	Breakdown Voltage V_{BR} @ I_T			Maximum Reverse Leakage I_R @ V_{RWM} (μA)	Working Peak Reverse Voltage V_{RWM} (V)	Maximum Reverse Surge Current I_{PP} (A)	Maximum Clamping Voltage V_C @ I_{PP} (V)
		Min (V)	Max (V)	I_T (mA)				
SA40	SA40C	44.40	54.30	1	5	40.0	7.00	71.4
SA40A	SA40CA	44.40	49.10	1	5	40.0	7.75	64.5
SA43	SA43C	47.80	58.40	1	5	43.0	6.52	76.7
SA43A	SA43CA	47.80	52.80	1	5	43.0	7.20	69.4
SA45	SA45C	50.00	61.10	1	5	45.0	6.23	80.3
SA45A	SA45CA	50.00	55.30	1	5	45.0	6.88	72.7
SA48	SA48C	53.30	65.10	1	5	48.0	5.85	85.5
SA48A	SA48CA	53.30	58.90	1	5	48.0	6.46	77.4
SA51	SA51C	56.70	69.30	1	5	51.0	5.49	91.1
SA51A	SA51CA	56.70	62.70	1	5	51.0	6.07	82.4
SA54	SA54C	60.00	73.30	1	5	54.0	5.19	96.3
SA54A	SA54CA	60.00	66.30	1	5	54.0	5.74	87.1
SA58	SA58C	64.40	78.70	1	5	58.0	4.85	103.0
SA58A	SA58CA	64.40	71.20	1	5	58.0	5.34	93.6
SA60	SA60C	66.70	81.50	1	5	60.0	4.67	107.0
SA60A	SA60CA	66.70	73.70	1	5	60.0	5.17	96.8
SA64	SA64C	71.10	86.90	1	5	64.0	4.39	114.0
SA64A	SA64CA	71.10	78.60	1	5	64.0	4.85	103.0
SA70	SA70C	77.80	95.10	1	5	70.0	4.00	125.0
SA70A	SA70CA	77.80	86.00	1	5	70.0	4.42	113.0
SA75	SA75C	83.30	102.00	1	5	75.0	3.73	134.0
SA75A	SA75CA	83.30	92.10	1	5	75.0	4.13	121.0
SA78	SA78C	86.70	106.00	1	5	78.0	3.60	139.0
SA78A	SA78CA	86.70	95.80	1	5	78.0	3.97	126.0
SA80	SA80C	88.96	108.80	1	5	80.0	3.49	143.2
SA80A	SA80CA	88.80	97.60	1	5	80.0	3.86	129.6
SA85	SA85C	94.40	115.00	1	5	85.0	3.31	151.0
SA85A	SA85CA	94.40	104.00	1	5	85.0	3.65	137.0
SA90	SA90C	100.00	122.00	1	5	90.0	3.13	160.0
SA90A	SA90CA	100.00	111.00	1	5	90.0	3.42	146.0
SA100	SA100C	111.00	136.00	1	5	100.0	2.79	179.0
SA100A	SA100CA	111.00	123.00	1	5	100.0	3.09	162.0
SA110	SA110C	122.00	149.00	1	5	110.0	2.55	196.0
SA110A	SA110CA	122.00	135.00	1	5	110.0	2.82	177.0
SA120	SA120C	133.00	163.00	1	5	120.0	2.34	214.0
SA120A	SA120CA	133.00	147.00	1	5	120.0	2.59	193.0
SA130	SA130C	144.00	176.00	1	5	130.0	2.16	231.0
SA130A	SA130CA	144.00	159.00	1	5	130.0	2.39	209.0
SA140	SA140C	155.68	190.40	1	5	140.0	2.00	250.6
SA140A	SA140CA	155.00	171.00	1	5	140.0	2.20	226.8
SA150	SA150C	167.00	204.00	1	5	150.0	1.87	268.0
SA150A	SA150CA	167.00	185.00	1	5	150.0	2.06	243.0
SA160	SA160C	178.00	218.00	1	5	160.0	1.74	287.0
SA160A	SA160CA	178.00	197.00	1	5	160.0	1.93	259.0
SA170	SA170C	189.00	231.00	1	5	170.0	1.64	304.0
SA170A	SA170CA	189.00	209.00	1	5	170.0	1.82	275.0
SA180	SA180C	200.16	244.80	1	5	180.0	1.55	322.2
SA180A	SA180CA	200.00	220.00	1	5	180.0	1.71	291.6
SA190	SA190C	211.28	258.40	1	5	190.0	1.47	340.1
SA190A	SA190CA	211.00	232.00	1	5	190.0	1.62	307.8